



N 沟道

20V/7A

RDS(ON)=15mΩ (typ.) @VGS=4.5V

RDS(ON)=20mΩ (typ.) @VGS=2.5V

P 沟道

-20V/-5.0A

RDS(ON)=36mΩ (typ.) @VGS= -4.5V

RDS(ON)=48mΩ (typ.) @VGS= -2.5V

特点

- 超高密度电池设计
- 可靠耐用
- 工作温度范围: -55~150°C

产品应用

- 用在笔记本电脑的电源管理系统
- 用在便携式设备和电池的供电系统

引脚示意

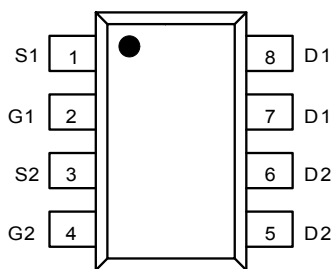

SOP-8

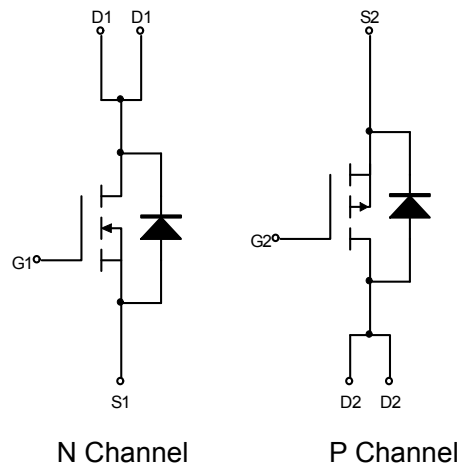

N Channel

P Channel

绝对最大额定值 (TA=25°C 除非另有说明)

符号	参数	N 沟道	P 沟道	单位
V _{DSS}	漏源电压	20	-20	V
I _D	漏极连续电流	7	-5.0	A
I _{DM}	漏极脉冲电流	24	-20	
T _J	工作结最高温度	150		°C
T _{STG}	储存温度范围	-55—150		
P _D	功耗	T _A =25°C	2	W
		T _A =100°C	0.8	
R _{θJA}	Thermal Resistance -Junction to Ambient	62.5		°C/W



电气特性 (TA=25°C, 除非另有说明)

符号	参数	测试条件	最小值	典型值	最大值	单位	
静态							
BV _{DSS}	漏极击穿电压	V _{GS} =0V, I _{DS} =250uF	N-CH	20		V	
		V _{GS} =0V, I _{DS} =-250uF	P-CH	-20			
I _{DSS}	零栅极电压漏极电流	V _{DS} =24V, V _{GS} =0V	N-CH		1	uA	
		V _{DS} =-24V, V _{GS} =0V	P-CH		-1		
V _{GS(TH)}	栅极阈值电压	V _{DS} =V _{GS} , I _{DS} =250uA	N-CH	0.5	0.7	1.1	V
		V _{DS} =V _{GS} , I _{DS} =-250uA	P-CH	-0.4	-0.75	-1.0	
I _{GSS}	栅极漏电流	V _{GS} =±12V, V _{DS} =0V	N-CH			±100	nA
			P-CH			±100	
R _{DS(ON)}	漏源导通电阻	V _{GS} =4.5V, I _{DS} =5A	N-CH		15	19	mΩ
			P-CH		36	46	
			N-CH		20	26	
			P-CH		48	60	

二极管							
V _{SD}	二极管正向电压	I _{SD} =2A, V _{GS} =0V	N-CH		0.7	1.3	V
		I _{SD} =-2.3A, V _{GS} =0V	P-CH		-1.7	-1.3	
动态							
R _G	栅极电阻	V _{GS} =0V, V _{DS} =0V, F=1MHZ	N-CH		2.2		Ω
			P-CH		11.5		
C _{ISS}	输入电容	N-Channel V _{GS} =0V V _{DS} =25V F=1MHZ	N-CH		846		pF
			P-CH		948		
C _{OSS}	输出电容	P-Channel V _{GS} =0V V _{DS} =-25V F=1MHZ	N-CH		151		
			P-CH		169		
C _{rSS}	反向传输电容	N-Channel V _{GS} =0V V _{DS} =-25V F=1MHZ	N-CH		16		ns
			P-CH		119		
t _{d(on)}	打开延时时间	N-Channel V _{DD} =15V, R _L =15Ω	N-CH		13	22	ns
			P-CH		14	26	
T _r	打开上升时	I _{DS} =1A, V _{GEN} =10V	N-CH		18	26	



	间	$R_G=6\ \Omega$	P-CH		14	28	
$T_{d(off)}$	关掉延时时间	P-Channel	N-CH		39	65	
			P-CH		37	62	
T_f	关掉下降时间	$V_{DD}=-15V, R_L=-15\ \Omega$ $I_{DS}=-1A, V_{GEN}=-10V$ $R_G=6\ \Omega$	N-CH		21	38	
			P-CH		16	32	
栅极电荷							
Q_g	栅极总电荷	N-Channel $V_{DS}=15V, V_{GS}=10V,$ $I_{DS}=7A$	N-CH		22	32	nC
			P-CH		34	45	
Q_{gs}	栅极源极电荷	P-Channel $V_{DS}=-15V, V_{GS}=-10V,$ $I_{DS}=-5.5A$	N-CH		1.8		
			P-CH		5.2		
Q_{gd}	栅极漏极电荷		N-CH		3.8		
			P-CH		4.1		

典型特征

N 沟道

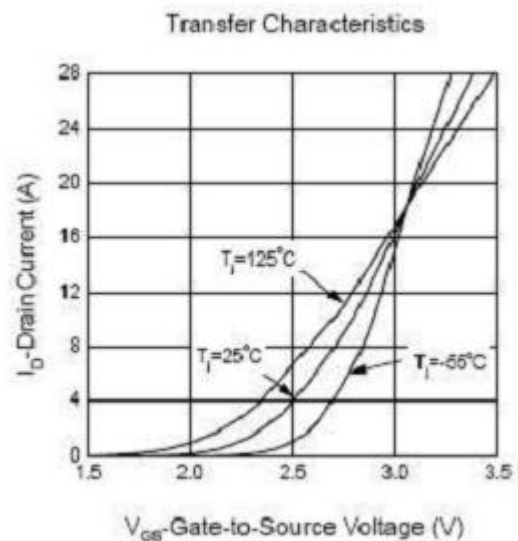
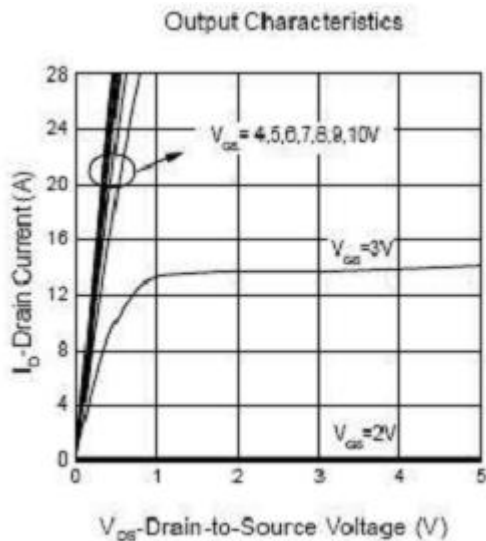

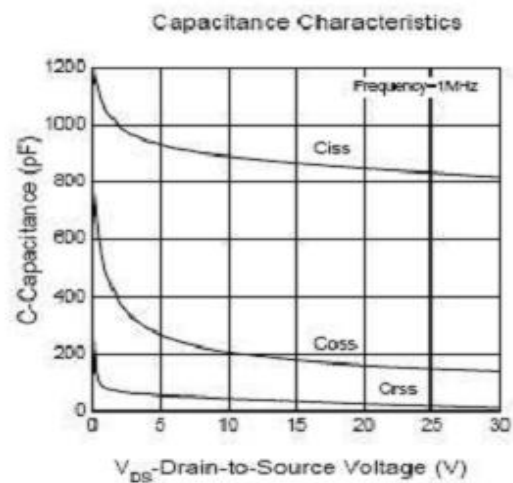
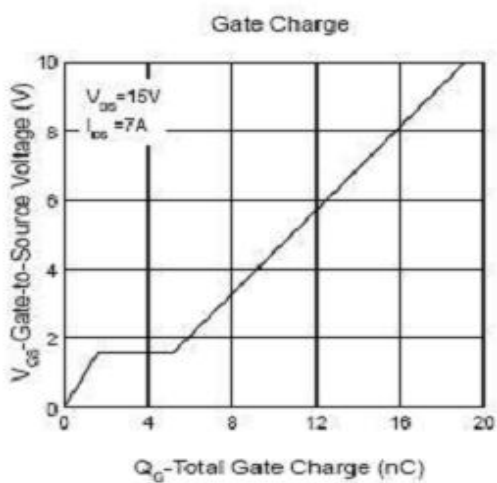
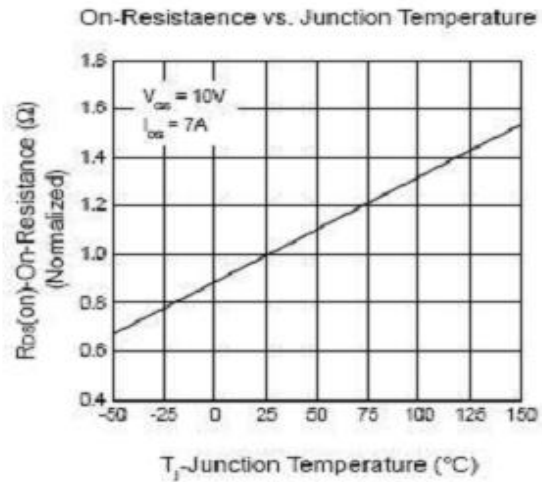
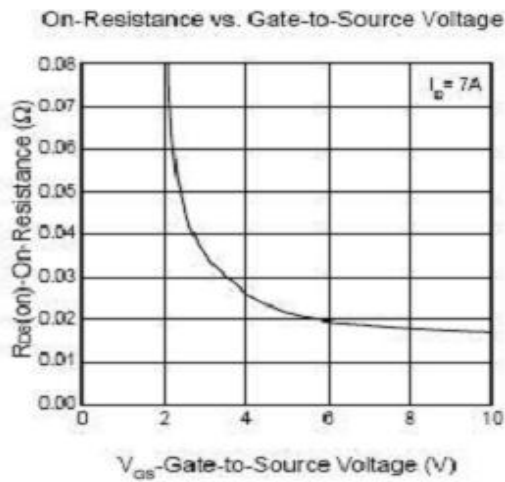
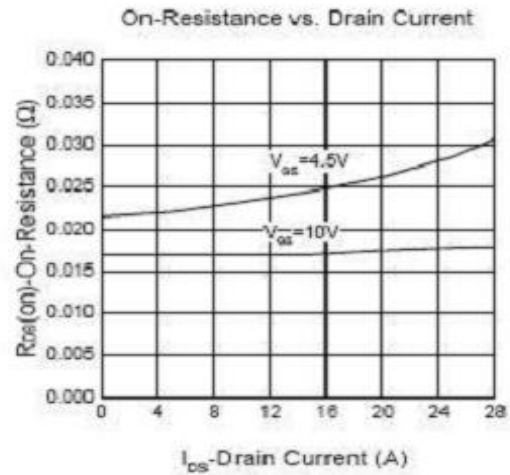
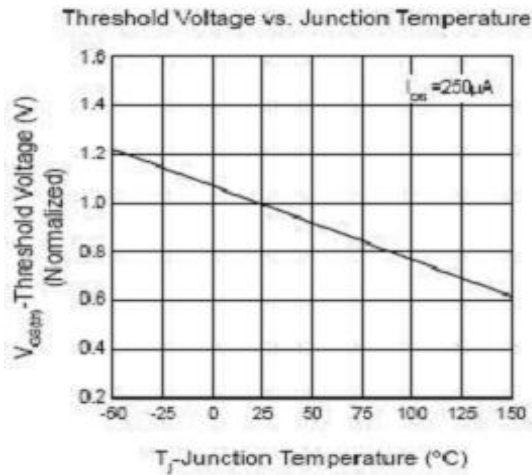

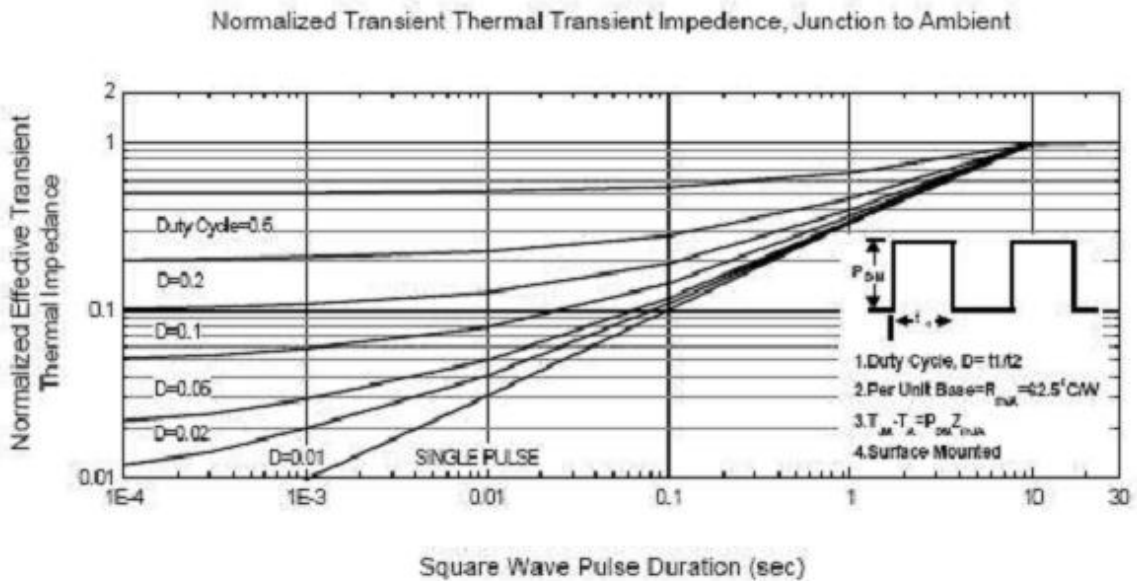
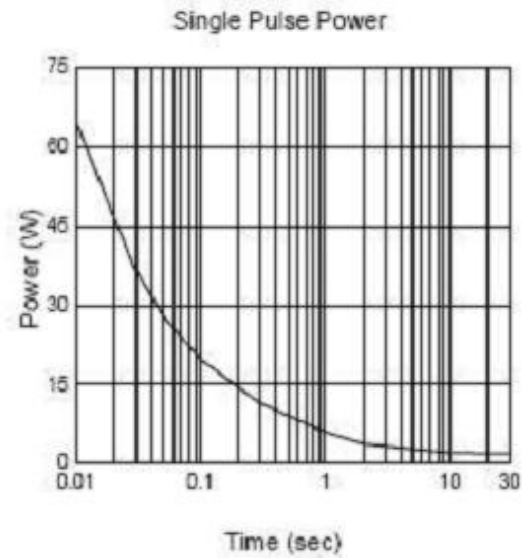
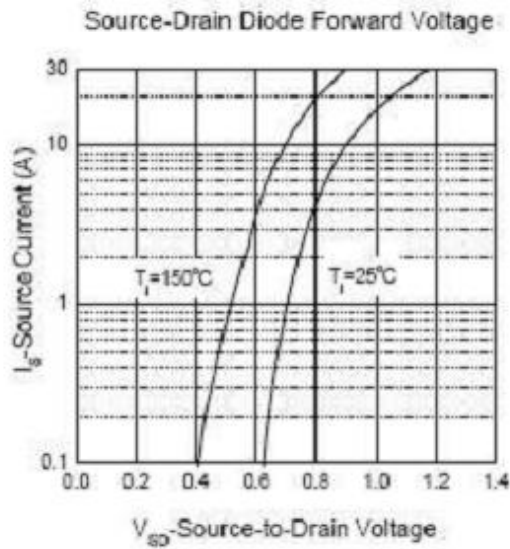



典型特性

P 沟道

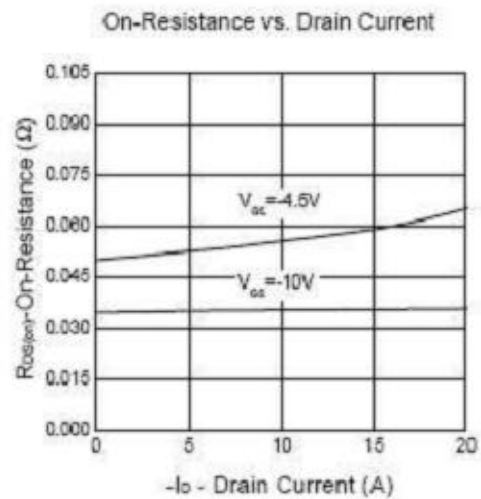
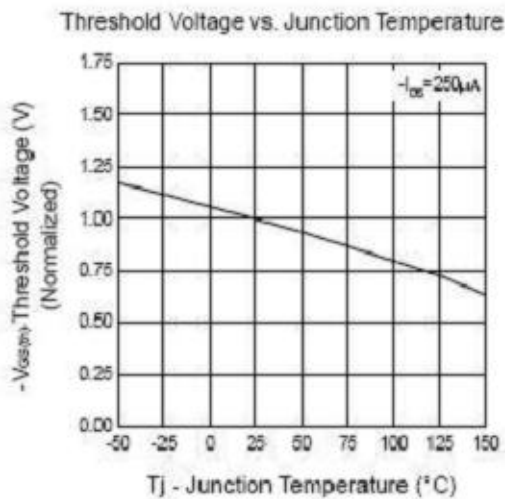
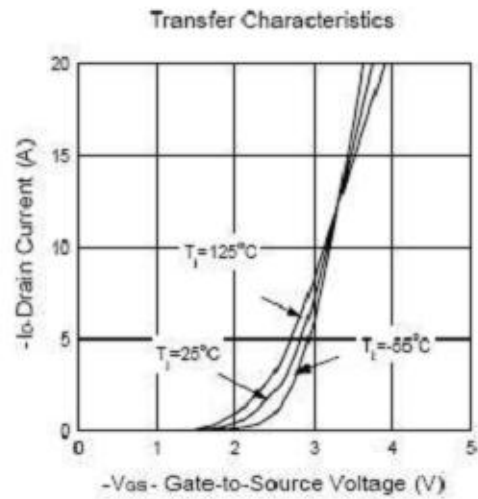
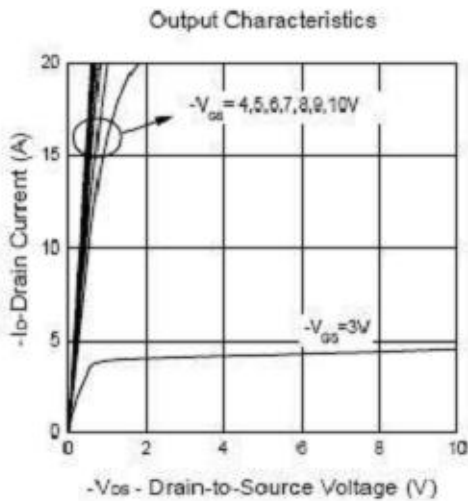

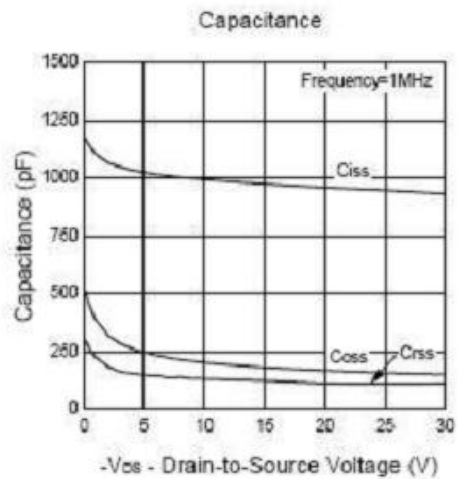
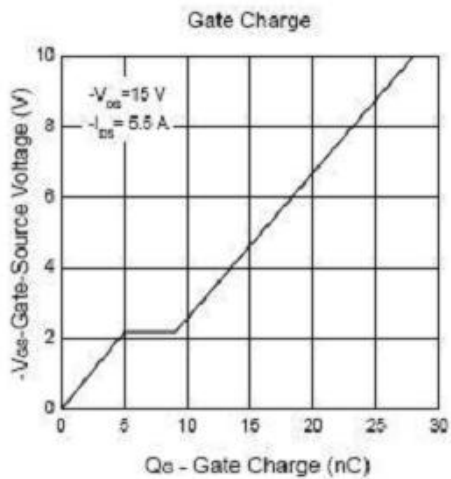
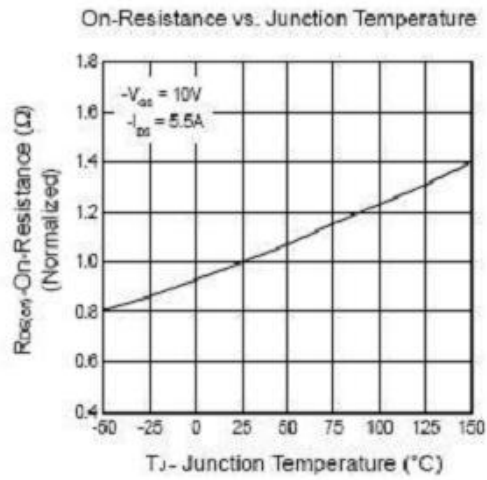
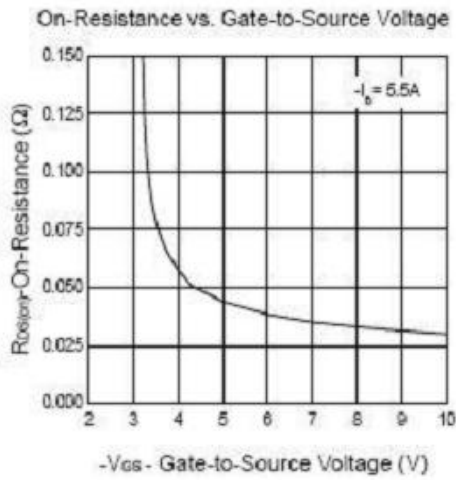

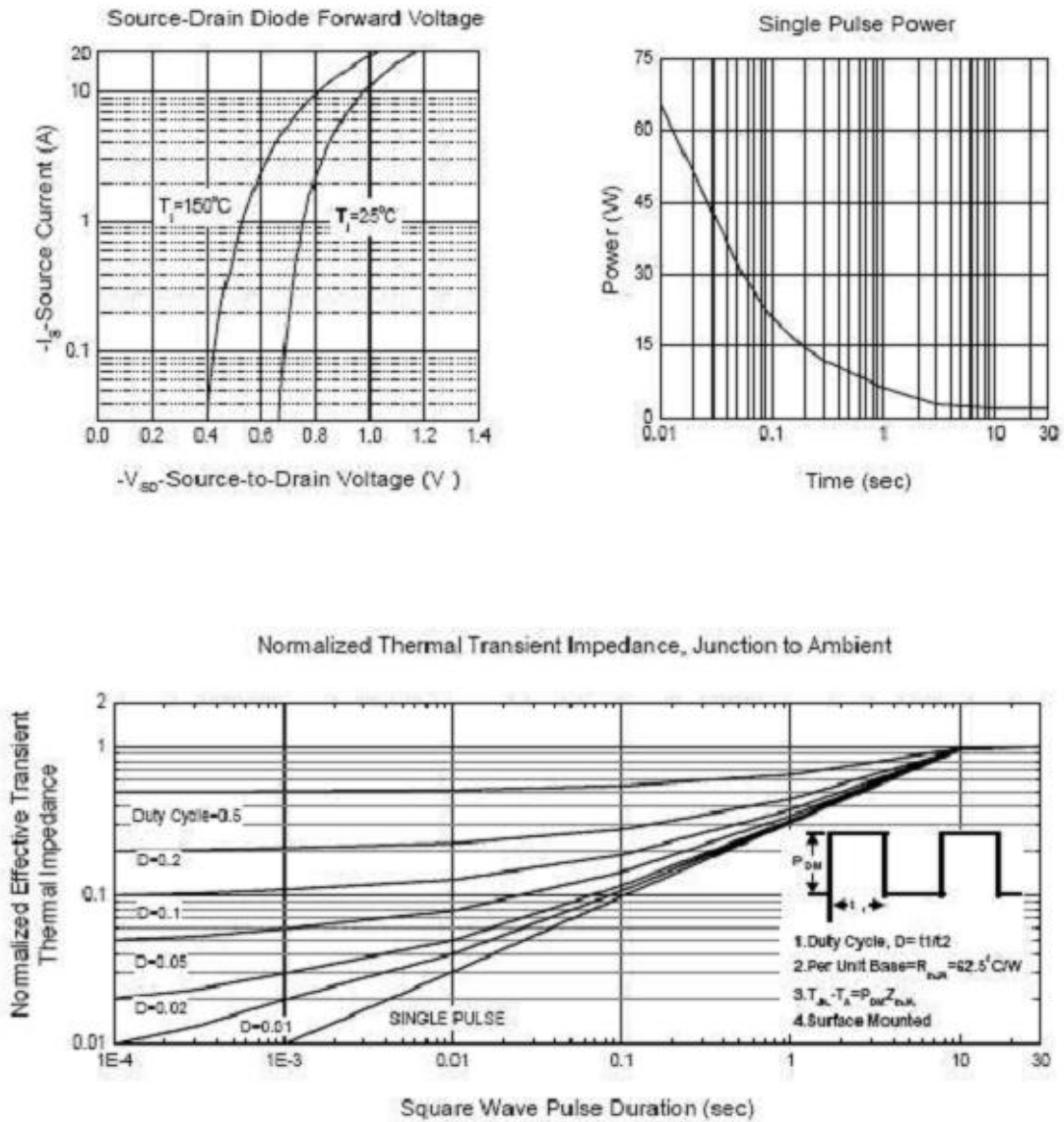



封装信息

SOP-8 pin (Reference JEDEC Registration MS-012)

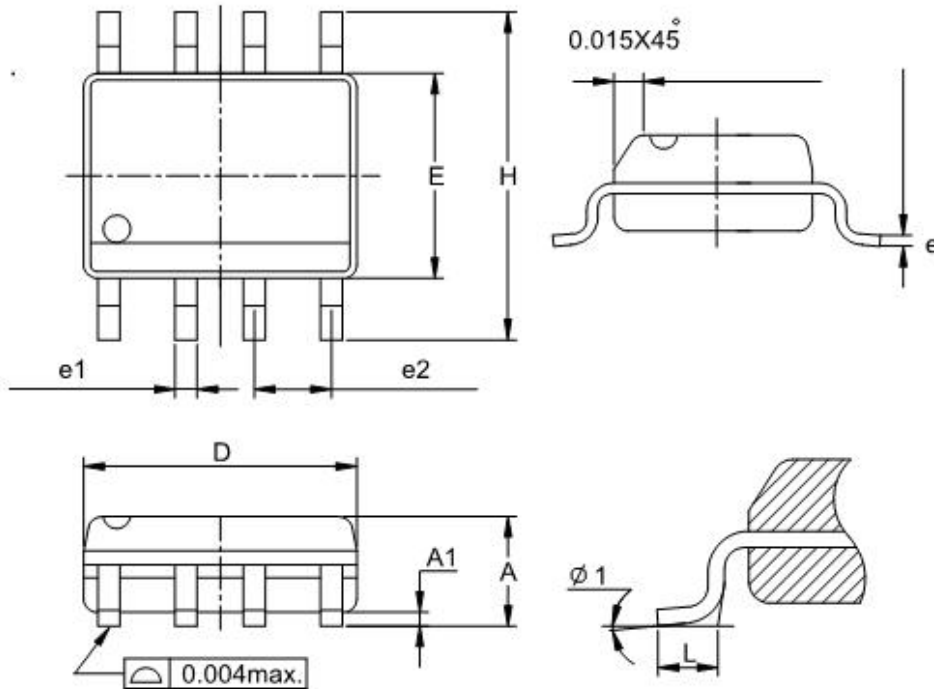

DIM	毫米		英寸	
	最小值	最大值	最小值	最大值
A	1.35	1.75	0.053	0.069
A1	0.10	0.25	0.004	0.010
D	4.80	5.00	0.189	0.197
E	3.80	4.00	0.150	0.157
H	5.80	6.20	0.228	0.244
L	0.40	1.27	0.016	0.050
E1	0.33	0.51	0.013	0.020
E2	1.27BSC		0.5BSC	
φ 1	8 °		8 °	