



TC4606B (文件编号: S&CIC1603)

双重增强型 MOSFET(N-P 沟道)

N 沟道

30V/7A

RDS(ON)=18mΩ (typ.) @VGS=10V

RDS(ON)=25mΩ (typ.) @VGS=4.5V

P 沟道

-30V/-5.5A

RDS(ON)=40mΩ (typ.) @VGS= -10V

RDS(ON)=62mΩ (typ.) @VGS= -4.5V

特点

- 超高密度电池设计
- 可靠耐用
- 封装形式: SOP-8
- 工作温度范围: -55~150°C

产品应用

- 用在笔记本电脑的电源管理系统
- 用在便携式设备和电池的供电系

引脚示意

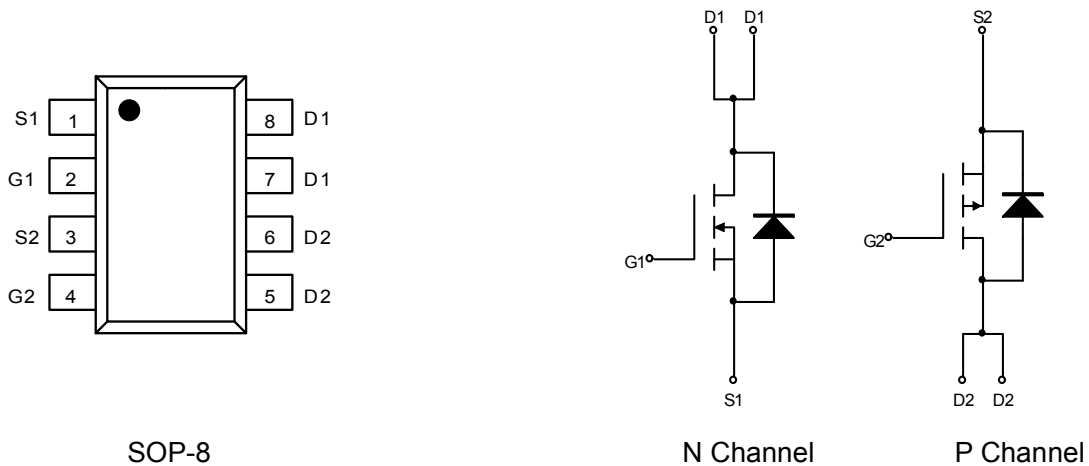

绝对最大额定值 (TA=25°C 除非另有说明)

符号	参数	N 沟道	P 沟道	单位
V _{DSS}	漏源电压	30	-30	V
I _D	漏极连续电流	7	-5.5	A
I _{DM}	漏极脉冲电流	28	-22	
T _J	工作结最高温度	150		°C
T _{STG}	储存温度范围	-55—150		
P _D	功耗	T _A =25°C	2	W
		T _A =100°C	0.8	
R _{θJA}	Thermal Resistance -Junction to Ambient	62.5		°C/W



电气特性 (TA=25°C, 除非另有说明)

符号	参数	测试条件	最小值	典型值	最大值	单位	
静态							
BV _{DSS}	漏极击穿电压	V _{GS} =0V, I _{DS} =250uF	N-CH	30		V	
		V _{GS} =0V, I _{DS} =-250uF	P-CH	-30			
I _{DSS}	零栅极电压漏极电流	V _{DS} =24V, V _{GS} =0V	N-CH		1	uA	
		V _{DS} =-24V, V _{GS} =0V	P-CH		-1		
V _{GS(TH)}	栅极阈值电压	V _{DS} =V _{GS} , I _{DS} =250uA	N-CH	1.0	1.6	2.5	V
		V _{DS} =V _{GS} , I _{DS} =-250uA	P-CH	-1.0	-1.8	-2.5	
I _{GSS}	栅极漏电流	V _{GS} =±20V, V _{DS} =0V	N-CH			±100	nA
			P-CH			±100	
R _{DS(ON)}	漏源导通电阻	V _{GS} =4.5V, I _{DS} =5A	N-CH		25	30	mΩ
			P-CH		62	80	
			N-CH		18	22	
			P-CH		40	55	

二极管							
V _{SD}	二极管正向电压	I _{SD} =2A, V _{GS} =0V	N-CH		0.8	1.2	V
		I _{SD} =-1A, V _{GS} =0V	P-CH		-1.5	-1.0	
动态							
R _G	栅极电阻	V _{GS} =0V, V _{DS} =0V, F=1MHZ	N-CH		2		Ω
			P-CH		11		
C _{ISS}	输入电容	N-Channel V _{GS} =0V V _{DS} =25V F=1MHZ P-Channel V _{GS} =0V V _{DS} =-25V F=1MHZ	N-CH		345		pF
			P-CH		560		
C _{OSS}	输出电容		N-CH		55		
			P-CH		55		
C _{rSS}	反向传输电容		N-CH		35		
			P-CH		40		
t _{d(on)}	打开延时时间	N-Channel V _{DD} =15V, R _L =15Ω	N-CH		11	20	ns
			P-CH		12	24	



T_r	打开上升时间	$I_{DS}=1A, V_{GEN}=10V$ $R_G=6\Omega$	N-CH	17	28
			P-CH	15	29
$T_{d(off)}$	关掉延时时间	P-Channel $V_{DD}=-15V, R_L=-15\Omega$	N-CH	36	62
			P-CH	35	60
T_f	关掉下降时间	$I_{DS}=-1A, V_{GEN}=-10V$ $R_G=6\Omega$	N-CH	20	36
			P-CH	15	30
栅极电荷					
Q_g	栅极总电荷	N-Channel $V_{DS}=15V, V_{GS}=10V,$ $I_{DS}=7A$	N-CH	4.1	nC
			P-CH	9.2	
Q_{gs}	栅极源极电荷	P-Channel $V_{DS}=-15V, V_{GS}=-10V,$ $I_{DS}=-5.5A$	N-CH	1	nC
			P-CH	1.6	
Q_{gd}	栅极漏极电荷		N-CH	2.1	nC
			P-CH	2.2	

典型特征

N 沟道

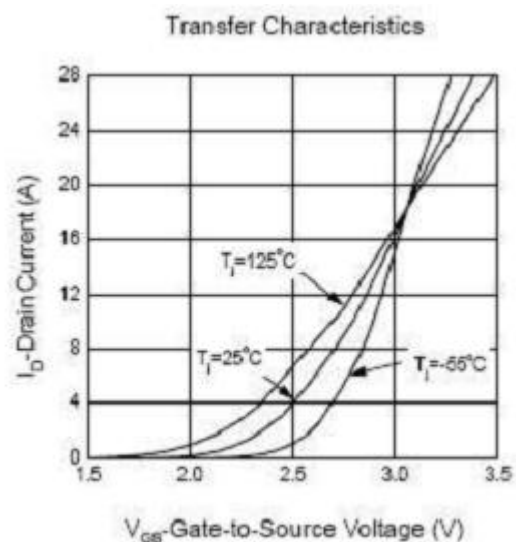
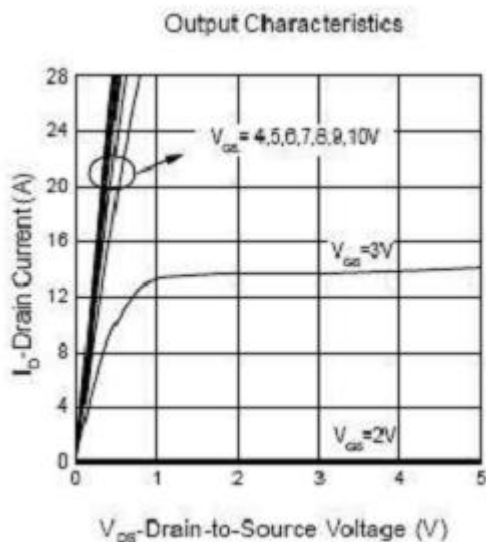

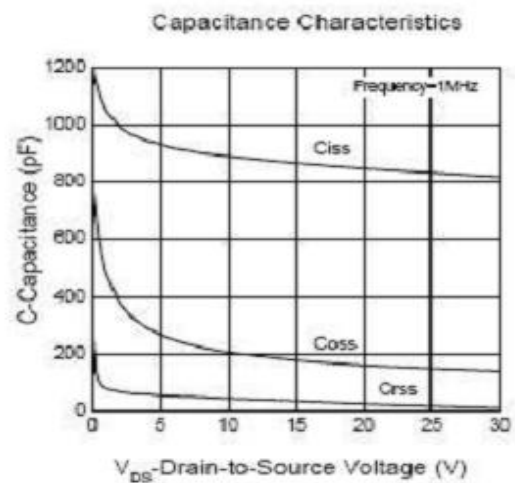
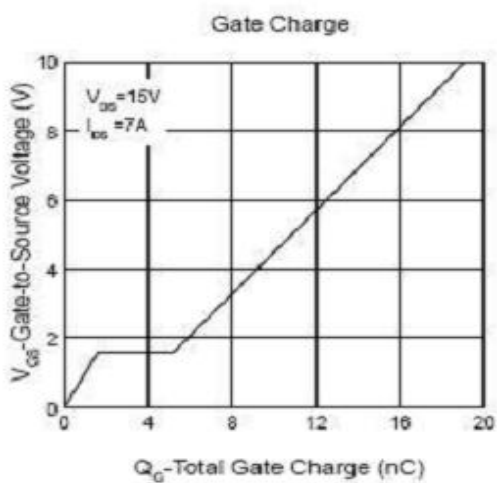
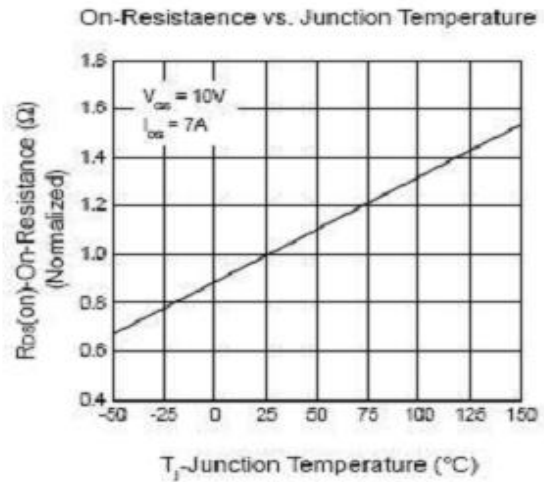
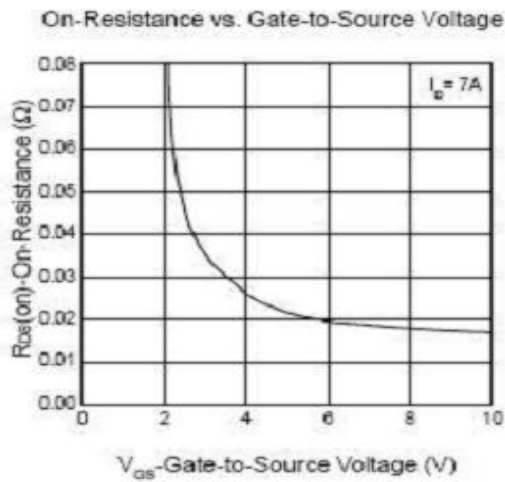
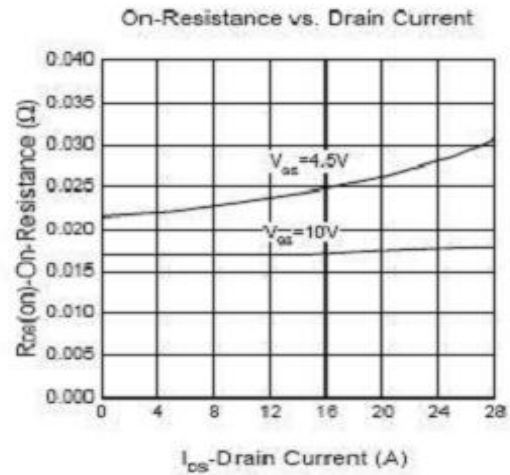
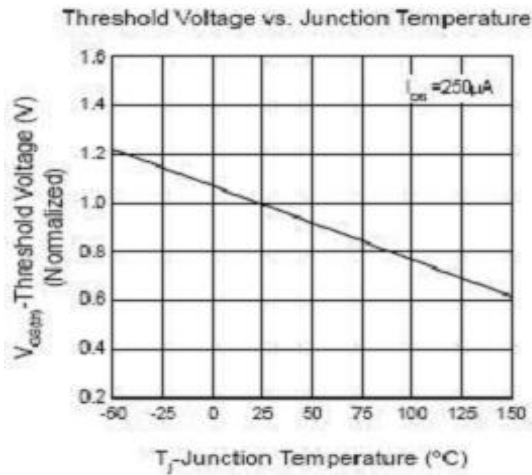

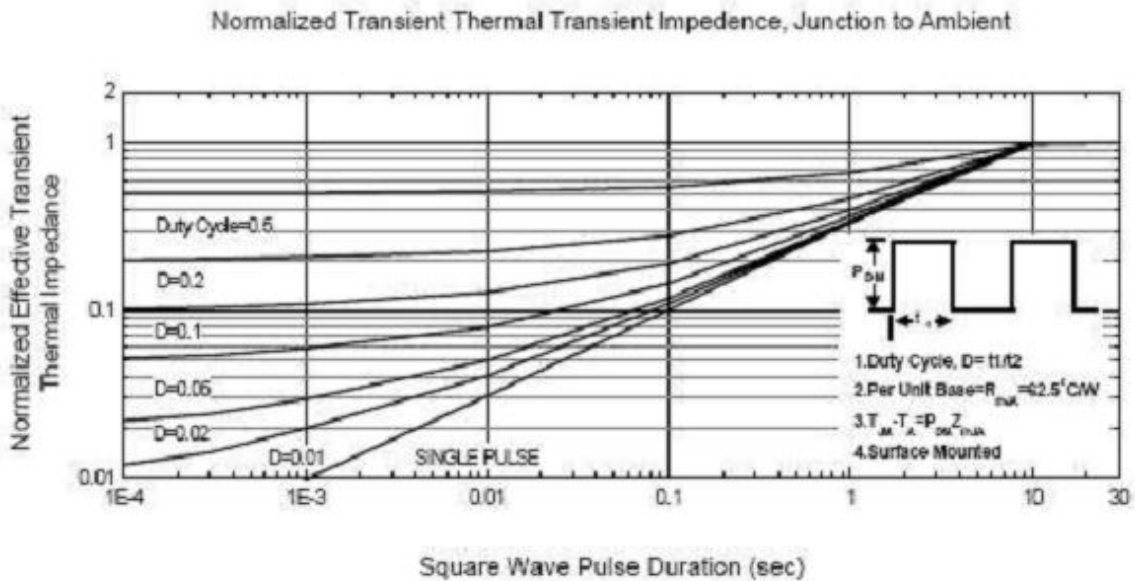
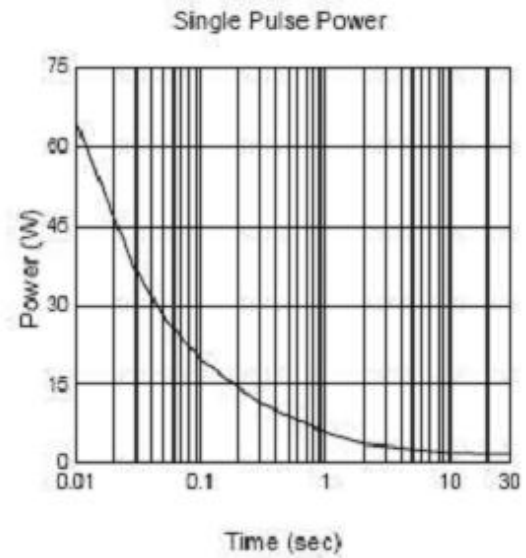
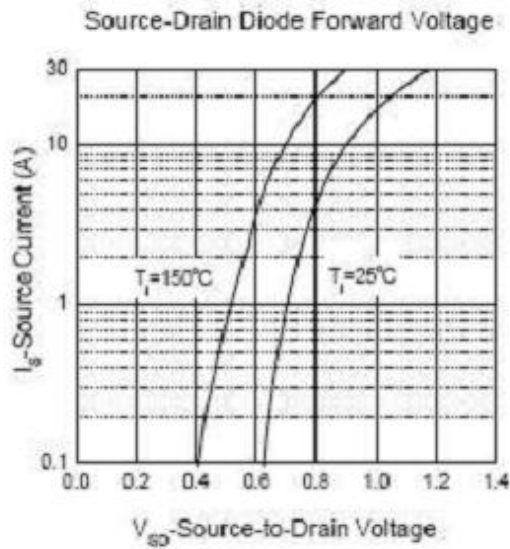



典型特性

P 沟道

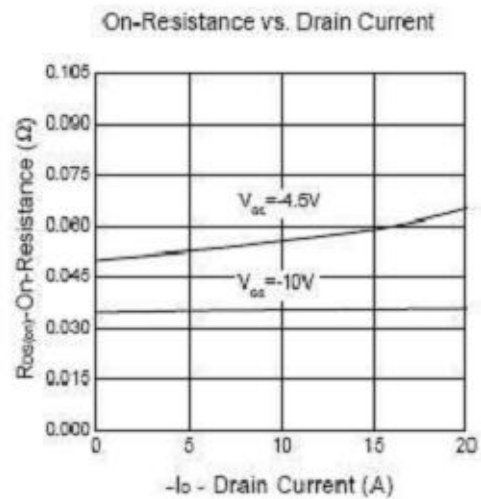
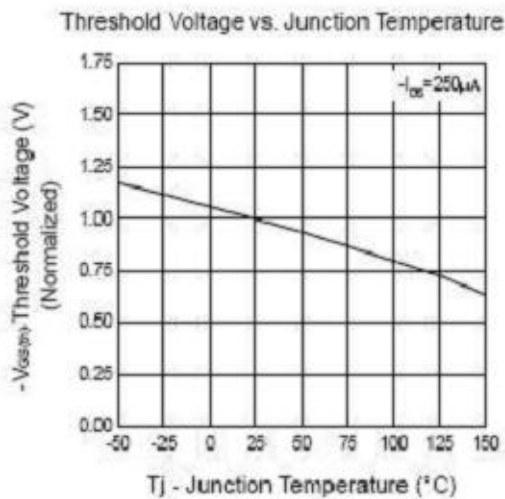
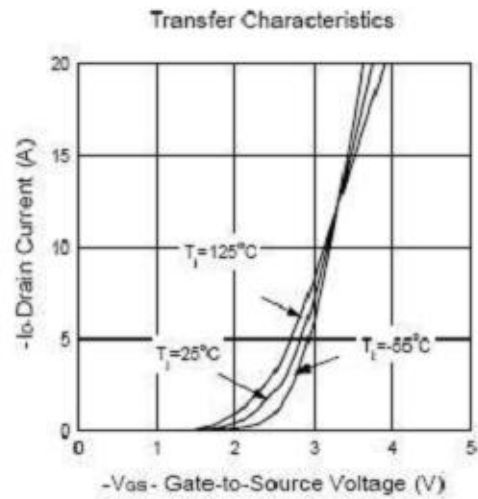
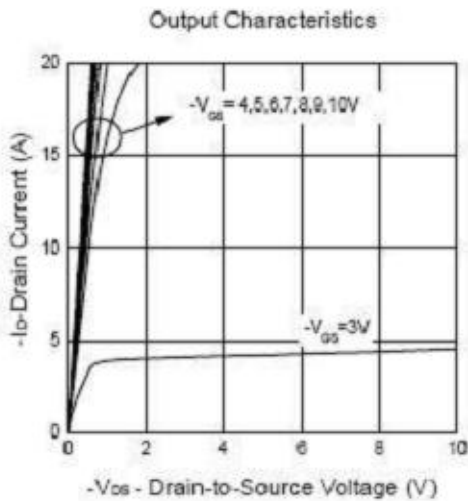

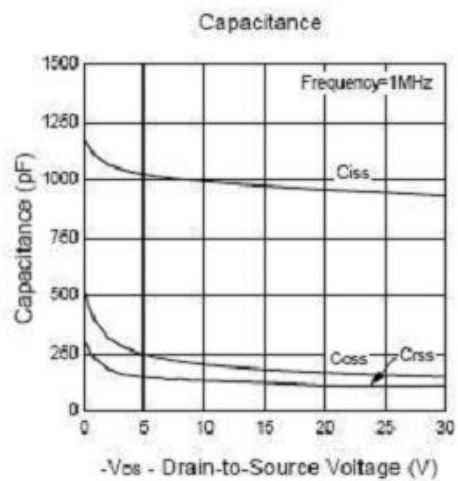
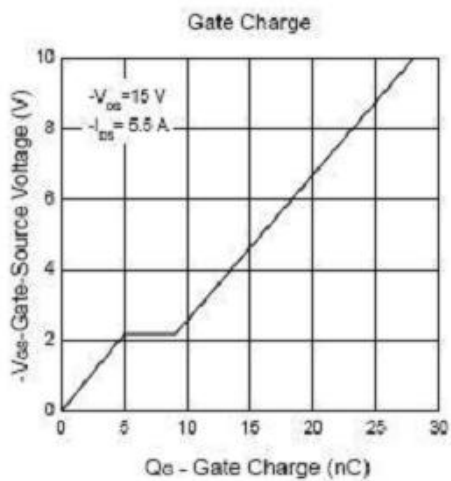
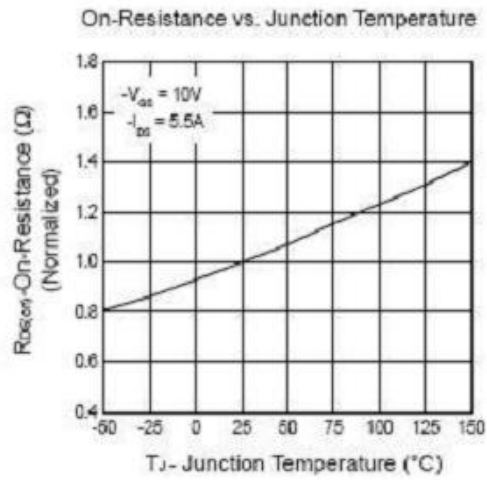
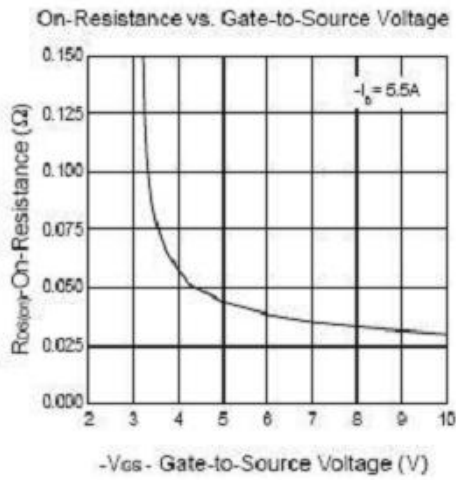

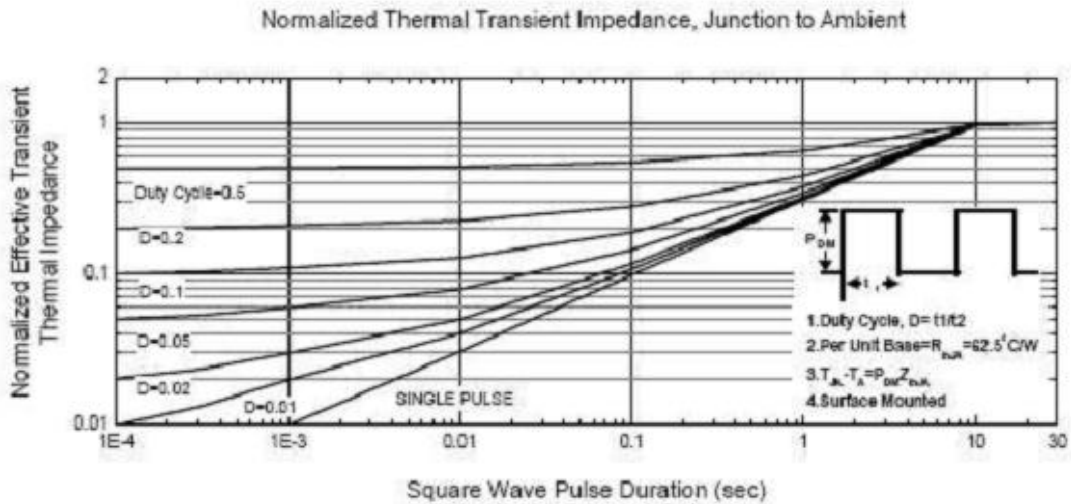
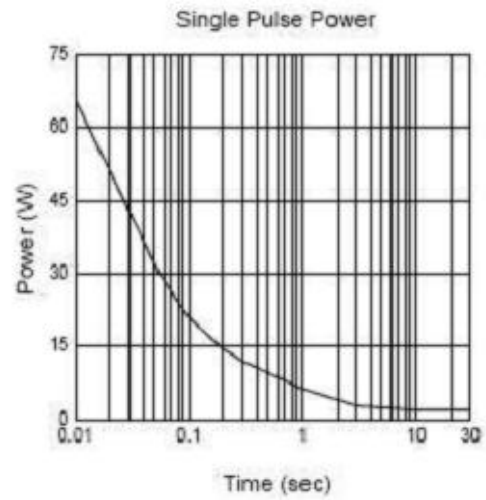
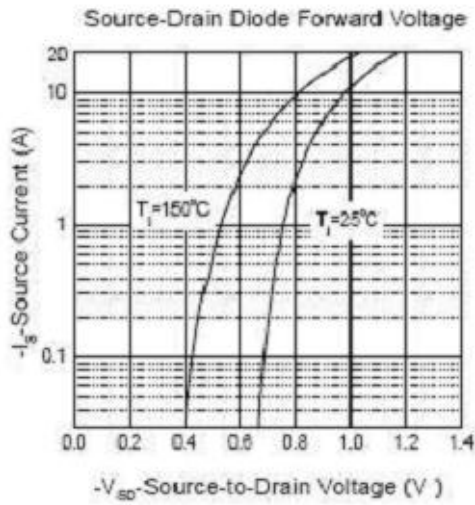



封装信息

SOP-8 pin (Reference JEDEC Registration MS-012)

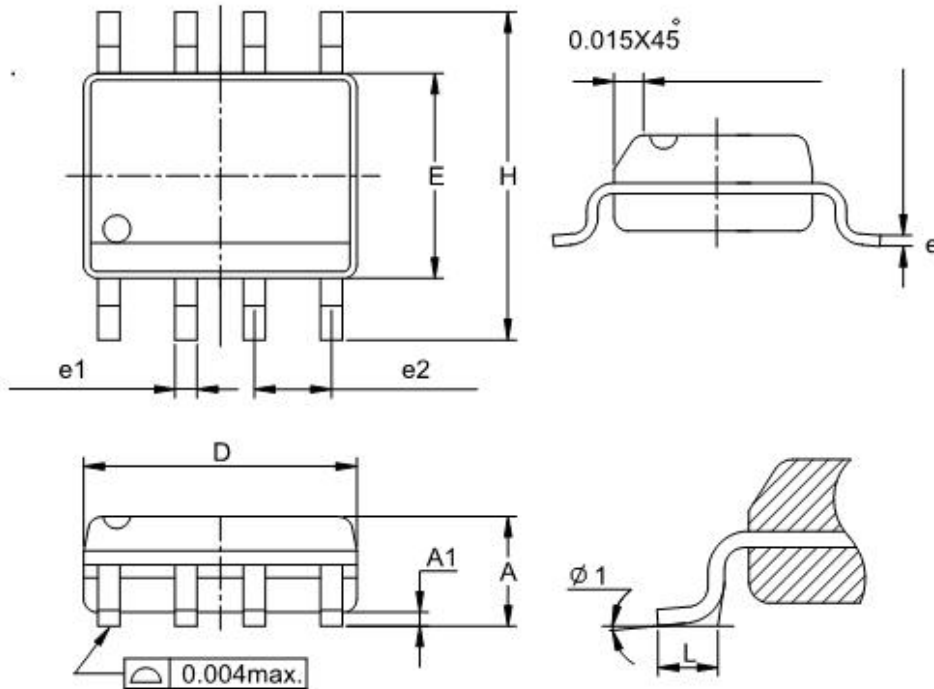

DIM	毫米		英寸	
	最小值	最大值	最小值	最大值
A	1.35	1.75	0.053	0.069
A1	0.10	0.25	0.004	0.010
D	4.80	5.00	0.189	0.197
E	3.80	4.00	0.150	0.157
H	5.80	6.20	0.228	0.244
L	0.40	1.27	0.016	0.050
E1	0.33	0.51	0.013	0.020
E2	1.27BSC		0.5BSC	
φ 1	8 °		8 °	